A photograph of a modern interior wood door. The door is dark brown with a vertical wood grain pattern. It is set in a light-colored wall. To the left of the door is a vertical panel with thin, closely spaced vertical lines. The door has a simple, dark handle. The floor is a light, neutral color.

**INTERIOR WOOD DOOR - LAMI SERIES**

McIlvaine  
Contract



Environment Protection



Sound Insulation



Moistureproof



Fire Prevention

## LAMI DOOR INTRODUCTION

### What's the LAMI DOOR?

LAMI Door is a kind of flush door decorated with durable low pressure decorative laminate.

### Why choose FB LAMI DOOR?

To realize affordable-cost and aesthetic, LAMI doors provides an ideal and economical solution for commercial projects, plenty of solid color, various pattern and wood grain options are available.

### Production Lead Time?

Standard 3 weeks to ship. Door to door shipping available.

### Features of FB LAMI DOOR?

- Supreme aesthetic
- Cost-effective
- Anti-scratch & durable, easy to maintain
- Moistureproof
- No painting in factory or onsite Eco-friendly
- Available with a wide range of glass lites, louvers and hardware preps
- Various colors, patterns, textures, customized color available to meet design request
- Specified with any door core type offered, including non-rated, fire rated and acoustic core

**Custom designs and sizes are available for both entry doors as well as interior doors.**





**TEAK 03**



01



02



03



04



05





**TEAK 08**



01



02



03



04



05





**TEAK 09**



01



02



03



04



05





**WALNUT 01**



01



02



03



04



05





**WALNUT 02**



01



02



03



04



05





**WALNUT 03**



01



02



03



04



05





01



02



03



04



05



06





RAL 9003



RAL 9010

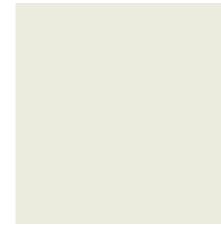

01



02



03



04



05





**EV OAK 02**



01



02



03



04



05





EV OAK 06



01



02



03



04



05



## HARDWARE OPTIONS



BJ79231



BJ79247



BJ79270



BJ74205



BJ74268



BJ74225



Magnetic mortise lock



4.5"X4.5" SS Hinge

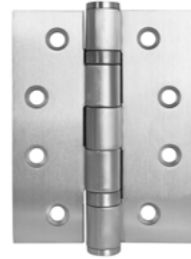

4"X3" SS Hinge



Zinc Alloyed Hidden hinge

## HARDWARE COLOR OPTIONS



PC Polished Chrome



MSN Matt Satin Nickel



BLK Matt Black

## JAMB & CASING TYPES

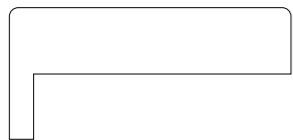

Casing-1 (W70)

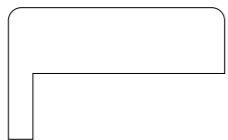

Casing-2 (W50)

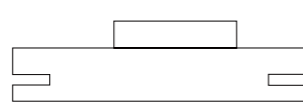

Jamb-1

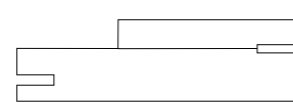

Jamb-2

## COLOR OPTIONS



RAL 9003



RAL 9010



EV OAK 2

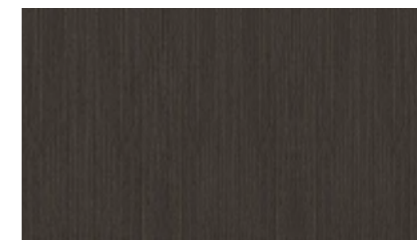

EV OAK 6

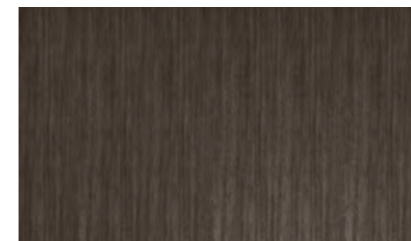

TEAK 3

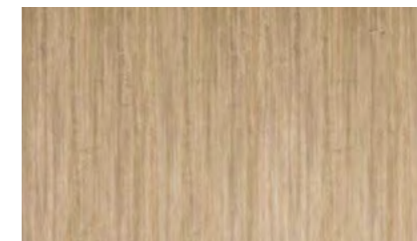

TEAK 8

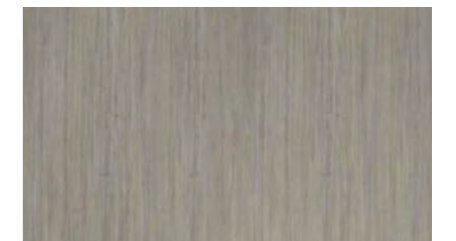

TEAK 9

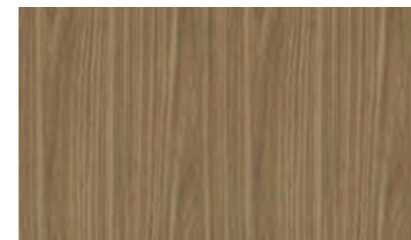

WALNUT 1

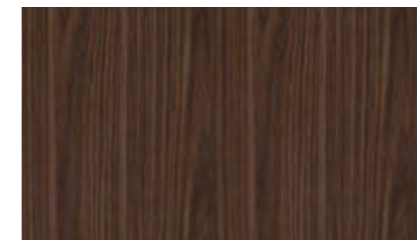

WALNUT 2

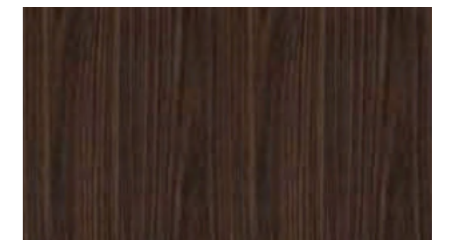

WALNUT 3



## TECHNICAL DRAWINGS

Pull Opening  
Adjustable jamb

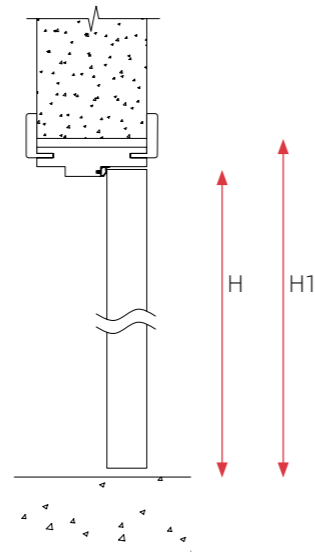
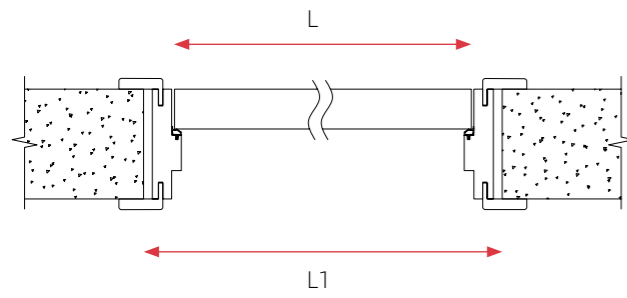

L - finished opening width

600-900mm, 24" -36"

H - finished opening height

Max 3000mm, 118 - 1/4"

L1 - rough opening width

L + 90mm

H1 - rough opening height

H + 55mm